

**PRICE CATALOG 2014**

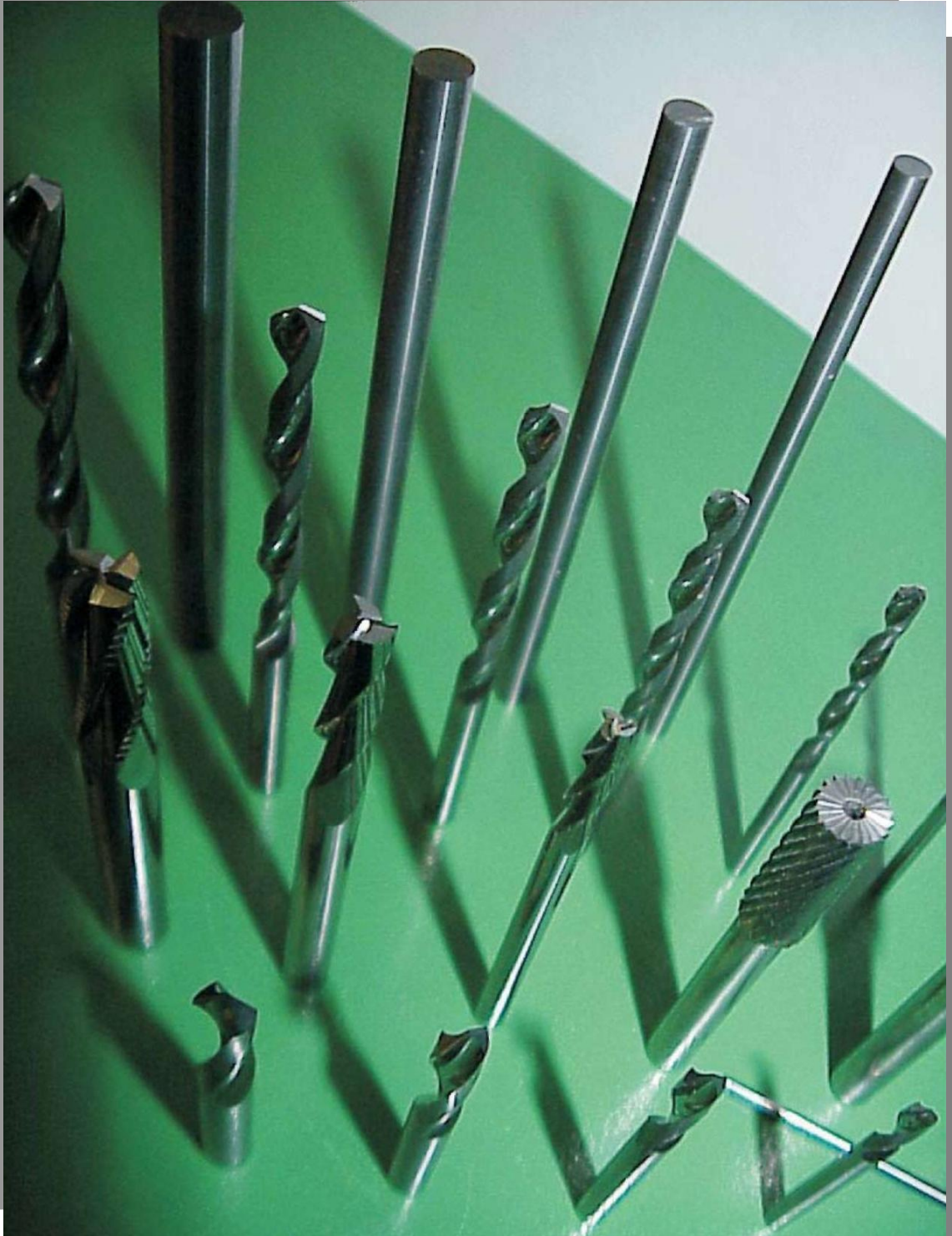



Armenian-Swiss company ASTRA has over 20 years of expertise in developing and manufacturing of high-precision *solid carbide tools* for numerous high-tech applications in electronic and mechanical manufacturing, jewelry, medicine, etc.

The ASTRA factory was planned and built turnkey by the Swiss company *Fela Planungs AG* and equipped by the other two Swiss companies - *Extramet* and *Sphinx*. Their technology is used to manufacture the tools from high-quality carbide rods produced by the European companies *Konrad Friedrichs*, *Sandvik* and *Ceratizit*. The whole staff of ASTRA was trained on the job at these companies.

Continuous quality control is carried out throughout the production cycle using high-precision Swiss measuring equipment. As a result, the following strict tolerances are met to assure a high accuracy and quality of the machined surfaces:

- Diameter tolerance – no more than 5  $\mu\text{m}$  over the length of 100 mm
- Non-cylindricity - no more than 3  $\mu\text{m}$  over the length of 100 mm
- Non-parallelism - no more than 5  $\mu\text{m}$  over the length of 100 mm.

ASTRA produces tools with cutting diameters starting at 0,100 mm and with grain size starting at ultra-fine 0,2-0,4  $\mu\text{m}$ . They show excellent performance and have a long life.

Should you not find the solid carbide tool of the shape, type, size or precision needed for your specific application, ASTRA can make it for you on request.

VARIOIMPEX is the Representative Office of ASTRA in Europe.

## CONTACTS

### Headquarters & Production

Armenian-Swiss Joint Venture ASTRA, Closed Joint-Stock Company

Address:	Phone: +374 10 74-06-20 or 73-37-00
ASTRA CJSC	Mobile: +374 91 40-28-92
Raffi Street 111	Fax: +374 10 54-54-74
0064 Yerevan	E-mail: <a href="mailto:astra@arminco.com">astra@arminco.com</a>
ARMENIA	Internet: <a href="http://www.astra.am">www.astra.am</a>

**CYLINDRICAL  
TWIST DRILLS**



**MICRO  
TWIST DRILLS**

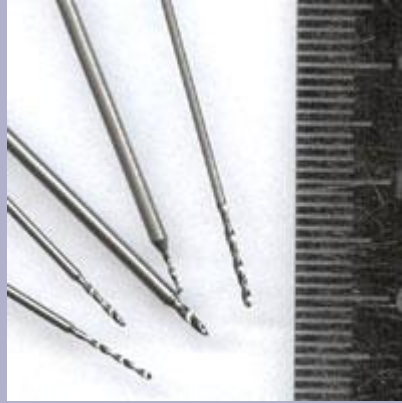

**TWIST DRILLS**

**PCB DRILLS - NORMAL**



**PCB DRILLS - LARGE**



**PCB DRILLS - MICRO**



**PCB DRILLS**

**PCB ROUTERS CHIPBREAKER**



**PCB ROUTERS**

**CENTER DRILLS**



**DOUBLE CENTER DRILLS**



**CENTER DRILLS**

**END MILLS**



**MICRO END MILLS**



**END MILLS**



**MINI BURS**





**MINI BURS**

**PUNCH PINS**



**PUNCH PINS**

**V-GROOVE ROUTERS**



**V-ROUTERS**

## Solid Carbide Cylindrical Twist Drills Type D25 (DIN 6539 / DIN 1897)

Grain Size	0,5..0,8 $\mu\text{m}$
Helix Angle	25°
Point Angle	118°

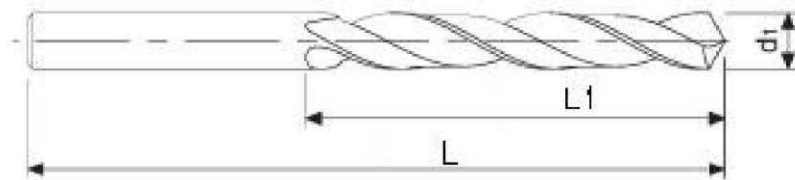

<i>d1 h6</i>	<i>L1</i>	<i>L</i>	<i>Code</i>	<i>Price</i>
<i>mm</i>	<i>mm</i>	<i>mm</i>	<i>D25xxxx</i>	<i>Euro</i>
0,5	3	20	D250050	5,40
0,6	3,5	21	D250060	5,40
0,7	4,5	23	D250070	5,40
0,8	5	24	D250080	5,10
0,9	5,5	25	D250090	5,10
1,0	6	26	D250100	5,00
1,1	7	28	D250110	5,70
1,2	8	30	D250120	5,70
1,3	8	30	D250130	5,70
1,4	9	32	D250140	5,70
1,5	9	32	D250150	6,00
1,6	10	34	D250160	6,00
1,7	10	34	D250170	6,50
1,8	11	36	D250180	6,50
1,9	11	36	D250190	6,50
2,0	12	38	D250200	7,40
2,1	12	38	D250210	7,40
2,2	13	40	D250220	7,40
2,3	13	40	D250230	7,40
2,4	14	43	D250240	7,40

See next page for end of the table.



## Solid Carbide Cylindrical Twist Drills Type D25 (DIN 6539 / DIN 1897)

See previous page for begin of the table.

<i>d1 h6</i>	<i>L1</i>	<i>L</i>	<i>Code</i>	<i>Price</i>
<i>mm</i>	<i>mm</i>	<i>mm</i>	<i>D25xxxx</i>	<i>Euro</i>
2,5	14	43	D250250	7,40
2,6	14	43	D250260	8,60
2,7	16	46	D250270	8,60
2,8	16	46	D250280	8,60
2,9	16	46	D250290	8,60
3,0	16	46	D250300	8,50
3,1	18	49	D250310	10,50
3,2	18	49	D250320	10,50
3,3	18	49	D250330	10,50
3,4	20	52	D250340	10,80
3,5	20	52	D250350	10,80
3,6	20	52	D250360	11,60
3,7	20	52	D250370	11,60
3,8	22	55	D250380	12,70
3,9	22	55	D250390	12,70
4,0	22	55	D250400	12,70
4,1	22	55	D250410	12,70
4,2	22	55	D250420	13,60
4,3	24	58	D250430	13,60
4,4	24	58	D250440	13,60
4,5	24	58	D250450	13,70
4,6	24	58	D250460	14,00
4,7	24	58	D250470	15,30
4,8	26	62	D250480	15,30
4,9	26	62	D250490	15,30
5,0	26	62	D250500	15,00
5,1	26	62	D250510	17,00
5,2	26	62	D250520	17,00
5,3	26	62	D250530	17,00
5,4	28	66	D250540	18,30
5,5	28	66	D250550	18,30
5,6	28	66	D250560	20,80
5,7	28	66	D250570	20,80
5,8	28	66	D250580	20,80
5,9	28	66	D250590	20,80
6,0	28	66	D250600	20,00

Special diameters and tolerances available on request.

## Solid Carbide Cylindrical Twist Drills Type D30 (DIN 338)

Grain Size	0,5..0,8 $\mu\text{m}$
Helix Angle	25°
Point Angle	118°

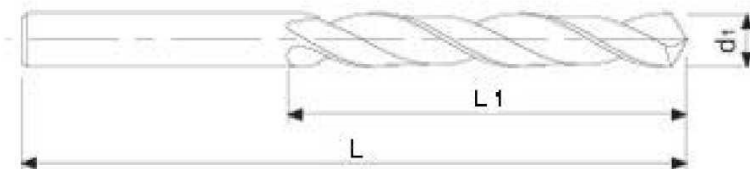

<i>d1 h6</i>	<i>L1</i>	<i>L</i>	<i>Code</i>	<i>Price</i>
<i>mm</i>	<i>mm</i>	<i>mm</i>	<i>D30xxxx</i>	<i>Euro</i>
0,5	6	22	D300050	6,70
0,6	7	24	D300060	6,70
0,7	9	28	D300070	6,70
0,8	10	30	D300080	6,70
0,9	11	32	D300090	6,70
1,0	12	34	D300100	6,70
1,1	14	36	D300110	7,90
1,2	16	38	D300120	7,90
1,3	16	38	D300130	7,90
1,4	18	40	D300140	7,90
1,5	18	40	D300150	7,90
1,6	20	43	D300160	8,50
1,7	20	43	D300170	8,50
1,8	22	46	D300180	9,30
1,9	22	46	D300190	9,30
2,0	24	49	D300200	9,30
2,1	24	49	D300210	10,00
2,2	27	53	D300220	11,10
2,3	27	53	D300230	11,10
2,4	30	57	D300240	11,70

See next page for end of the table.





## Solid Carbide Cylindrical Twist Drills Type D30 (DIN 338)

See previous page for begin of the table.

<b>d1 h6</b>	<b>L1</b>	<b>L</b>	<b>Code</b>	<b>Price</b>
<i>mm</i>	<i>mm</i>	<i>mm</i>	<i>D30xxxx</i>	<i>Euro</i>
2,5	30	57	D300250	11,00
2,6	30	57	D300260	12,60
2,7	33	61	D300270	12,60
2,8	33	61	D300280	13,90
2,9	33	61	D300290	13,90
3,0	33	61	D300300	12,80
3,1	36	65	D300310	14,60
3,2	36	65	D300320	14,60
3,3	36	65	D300330	14,60
3,4	39	70	D300340	17,00
3,5	39	70	D300350	16,20
3,6	39	70	D300360	17,70
3,7	39	70	D300370	17,70
3,8	43	75	D300380	18,50
3,9	43	75	D300390	18,50
4,0	43	75	D300400	17,70
4,1	43	75	D300410	19,90
4,2	43	75	D300420	19,90
4,3	47	80	D300430	21,60
4,4	47	80	D300440	22,30
4,5	47	80	D300450	21,60
4,6	47	80	D300460	23,70
4,7	47	80	D300470	23,70
4,8	52	86	D300480	26,20
4,9	52	86	D300490	26,20
5,0	52	86	D300500	25,30
5,1	52	86	D300510	28,50
5,2	52	86	D300520	28,50
5,3	52	86	D300530	28,50
5,4	57	93	D300540	32,30
5,5	57	93	D300550	30,80
5,6	57	93	D300560	33,90
5,7	57	93	D300570	33,90
5,8	57	93	D300580	36,70
5,9	57	93	D300590	36,70
6,0	57	93	D300600	33,90

Special diameters and tolerances available on request.

## Solid Carbide Cylindrical Twist Drills Type D35 (ASTRA Standard)

<b>Grain Size</b>	0,5..0,8 $\mu\text{m}$
<b>Helix Angle</b>	25°
<b>Point Angle</b>	118°

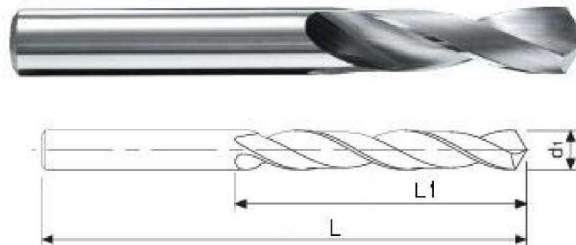

<b>d1 h6</b>	<b>L1</b>	<b>L</b>	<b>Code</b>	<b>Price</b>	<b>d1 h6</b>	<b>L1</b>	<b>L</b>	<b>Code</b>	<b>Price</b>
<i>mm</i>	<i>mm</i>	<i>mm</i>	<i>D35xxxx</i>	<i>Euro</i>	<i>mm</i>	<i>mm</i>	<i>mm</i>	<i>D35xxxx</i>	<i>Euro</i>
0,30	4	28	D350030	7,20	1,40	12	30	D350140	6,20
0,35	5	30	D350035	7,20	1,45	12	30	D350145	6,20
0,40	5	30	D350040	7,20	1,50	12	30	D350150	6,20
0,45	5	30	D350045	7,20	1,55	16	40	D350155	7,60
0,50	5	30	D350050	5,90	1,60	16	40	D350160	7,60
0,55	5	30	D350055	6,90	1,65	16	40	D350165	7,40
0,60	5	30	D350060	5,70	1,70	16	40	D350170	7,20
0,65	6	30	D350065	6,90	1,75	16	40	D350175	7,40
0,70	6	30	D350070	5,70	1,80	16	40	D350180	6,90
0,75	8	30	D350075	6,10	1,85	16	40	D350185	7,40
0,80	8	30	D350080	5,60	1,90	16	40	D350190	6,90
0,85	9	30	D350085	6,20	1,95	16	40	D350195	7,40
0,90	9	30	D350090	5,70	2,00	16	40	D350200	6,90
0,95	10	30	D350095	6,20	2,05	16	40	D350205	7,70
1,00	10	30	D350100	5,30	2,10	18	40	D350210	7,90
1,05	10	30	D350105	6,20	2,15	18	40	D350215	8,00
1,10	10	30	D350110	5,60	2,20	18	40	D350220	8,00
1,15	12	30	D350115	6,20	2,25	18	40	D350225	8,00
1,20	12	30	D350120	6,20	2,30	18	40	D350230	8,00
1,25	12	30	D350125	6,20	2,35	18	40	D350235	8,00
1,30	12	30	D350130	6,20	2,40	18	40	D350240	7,70
1,35	12	30	D350135	6,20	2,45	18	40	D350245	8,00

See next page for end of the table.



## Solid Carbide Cylindrical Twist Drills Type D35 (ASTRA Standard)

See previous page for begin of the table.

<b>d1 h6</b>	<b>L1</b>	<b>L</b>	<b>Code</b>	<b>Price</b>	<b>d1 h6</b>	<b>L1</b>	<b>L</b>	<b>Code</b>	<b>Price</b>
<i>mm</i>	<i>mm</i>	<i>mm</i>	<i>D35xxxx</i>	<i>Euro</i>	<i>mm</i>	<i>mm</i>	<i>mm</i>	<i>D35xxxx</i>	<i>Euro</i>
<b>2,50</b>	18	40	D350250	9,20	<b>4,00</b>	20	50	D350400	13,60
<b>2,55</b>	18	45	D350255	9,20	<b>4,10</b>	25	50	D350410	16,80
<b>2,60</b>	18	45	D350260	9,20	<b>4,20</b>	25	50	D350420	16,80
<b>2,65</b>	18	45	D350265	10,50	<b>4,30</b>	25	50	D350430	20,30
<b>2,70</b>	18	45	D350270	10,50	<b>4,40</b>	25	50	D350440	20,30
<b>2,75</b>	18	45	D350275	10,50	<b>4,50</b>	25	50	D350450	17,70
<b>2,80</b>	18	45	D350280	11,20	<b>4,60</b>	25	50	D350460	20,80
<b>2,85</b>	18	45	D350285	11,20	<b>4,70</b>	25	50	D350470	20,80
<b>2,90</b>	18	45	D350290	11,20	<b>4,80</b>	25	50	D350480	21,60
<b>2,95</b>	18	45	D350295	9,90	<b>4,90</b>	25	50	D350490	21,60
<b>3,00</b>	18	45	D350300	9,90	<b>5,00</b>	25	50	D350500	19,90
<b>3,10</b>	20	50	D350310	11,60	<b>5,10</b>	25	50	D350510	22,30
<b>3,175</b>	20	50	D350318	11,60	<b>5,20</b>	25	50	D350520	22,30
<b>3,20</b>	20	50	D350320	11,60	<b>5,30</b>	25	50	D350530	24,50
<b>3,30</b>	20	50	D350330	12,00	<b>5,40</b>	25	50	D350540	24,50
<b>3,40</b>	20	50	D350340	12,20	<b>5,50</b>	25	50	D350550	23,40
<b>3,50</b>	20	50	D350350	12,20	<b>5,60</b>	25	50	D350560	24,50
<b>3,60</b>	20	50	D350360	14,60	<b>5,70</b>	25	50	D350570	24,50
<b>3,70</b>	20	50	D350370	14,60	<b>5,80</b>	25	50	D350580	28,50
<b>3,80</b>	20	50	D350380	16,80	<b>5,90</b>	25	50	D350590	28,50
<b>3,90</b>	20	50	D350390	16,80	<b>6,00</b>	25	50	D350600	24,50

Special diameters and tolerances available on request.

## Solid Carbide Cylindrical Micro Twist Drills Type DTC35

<b>Material</b>	Tungsten Carbide + 10% Co
<b>Grain Size</b>	0,4..0,5 $\mu\text{m}$
<b>Helix Angle</b>	25° ..35°
<b>Point Angle</b>	118°

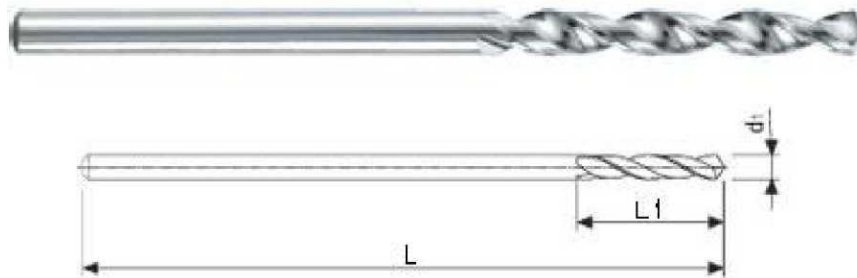

For all sizes the overall length  $L=30,0$  mm.

<b>d1 h6</b> mm	<b>L1</b> mm	<b>Code</b> DTC35xxxx	<b>Price</b> Euro	<b>d1 h6</b> mm	<b>L1</b> mm	<b>Code</b> DTC35xxxx	<b>Price</b> Euro
0,30	6,0	DTC350030	10,50	1,20	16,0	DTC350120	7,50
0,35	6,0	DTC350035	9,70	1,25	16,0	DTC350125	8,00
0,40	6,0	DTC350040	9,20	1,30	16,0	DTC350130	7,50
0,45	9,0	DTC350045	11,40	1,35	16,0	DTC350135	8,00
0,50	9,0	DTC350050	8,10	1,40	16,0	DTC350140	7,50
0,55	9,0	DTC350055	8,10	1,45	16,0	DTC350145	8,00
0,60	9,0	DTC350060	8,30	1,50	16,0	DTC350150	7,40
0,65	9,0	DTC350065	8,90	1,55	16,0	DTC350155	7,50
0,70	13,0	DTC350070	8,10	1,60	16,0	DTC350160	7,20
0,75	13,0	DTC350075	8,90	1,65	16,0	DTC350165	7,50
0,80	13,0	DTC350080	7,40	1,70	16,0	DTC350170	7,20
0,85	13,0	DTC350085	8,10	1,75	16,0	DTC350175	7,50
0,90	16,0	DTC350090	7,80	1,80	16,0	DTC350180	7,20
0,95	16,0	DTC350095	8,30	1,85	16,0	DTC350185	7,50
1,00	16,0	DTC350100	7,10	1,90	16,0	DTC350190	7,20
1,05	16,0	DTC350105	7,90	1,95	16,0	DTC350195	7,50
1,10	16,0	DTC350110	7,50	2,00	16,0	DTC350200	7,20

Special diameters and tolerances available on request.

## Solid Carbide Micro Twist Drills Type DT25 / DT25L (L for left-hand cut)

Grain Size	0,4..0,5 $\mu\text{m}$
Helix Angle	25° or 36°
Point Angle	118°

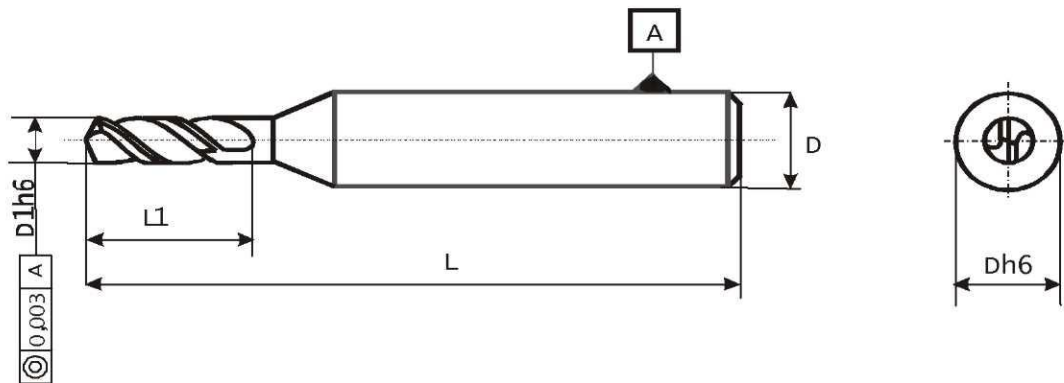

For all sizes the overall length L=30,0 mm.

<i>D1h6</i>	<i>Dh6</i>	<i>L1</i>	<i>Code</i>	<i>Price</i>	<i>D1h6</i>	<i>Dh6</i>	<i>L1</i>	<i>Code</i>	<i>Price</i>
<i>mm</i>	<i>mm</i>	<i>mm</i>	<i>DT25(L)xxxx</i>	<i>Euro</i>	<i>mm</i>	<i>mm</i>	<i>mm</i>	<i>DT25(L)xxxx</i>	<i>Euro</i>
0,20	1,0	3,0	DT250020	10,80	1,10	1,5	10,0	DT250110	8,20
0,25	1,0	3,0	DT250025	10,80	1,15	1,5	12,0	DT250115	8,50
0,30	1,0	3,0	DT250030	10,80	1,20	1,5	12,0	DT250120	8,20
0,35	1,0	4,0	DT250035	10,50	1,25	1,5	12,0	DT250125	8,50
0,40	1,0	4,0	DT250040	10,50	1,30	1,5	12,0	DT250130	8,20
0,45	1,0	6,0	DT250045	11,50	1,35	1,5	12,0	DT250135	8,50
0,50	1,0	6,0	DT250050	8,50	1,40	1,5	12,0	DT250140	8,20
0,55	1,0	6,0	DT250055	8,50	1,45	1,5	12,0	DT250145	8,60
0,60	1,0	6,0	DT250060	8,50	1,50	2,0	12,0	DT250150	10,00
0,65	1,0	7,0	DT250065	8,50	1,55	2,0	12,0	DT250155	10,00
0,70	1,0	7,0	DT250070	8,50	1,60	2,0	12,0	DT250160	10,00
0,75	1,5	8,0	DT250075	8,80	1,65	2,0	12,0	DT250165	10,00
0,80	1,5	8,0	DT250080	8,00	1,70	2,0	12,0	DT250170	10,00
0,85	1,5	8,0	DT250085	8,00	1,75	2,0	12,0	DT250175	10,00
0,90	1,5	8,0	DT250090	8,00	1,80	2,0	12,0	DT250180	10,00
0,95	1,5	10,0	DT250095	8,00	1,85	2,0	12,0	DT250185	10,00
1,00	1,5	10,0	DT250100	8,20	1,90	2,0	12,0	DT250190	10,00
1,05	1,5	10,0	DT250105	8,50	1,95	2,0	12,0	DT250195	10,00
					2,00	2,0	12,0	DT250200	11,10

Special diameters and tolerances available on request.



## Solid Carbide Twist Drills for Jewelers Type DJ

The following dimensions are shared by all sizes:

<i>d2</i>	<i>l1</i>	<i>l2</i>
<i>mm</i>	<i>mm</i>	<i>mm</i>
2,35	38,10	5,50

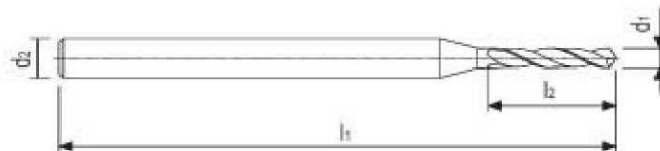

<i>d1</i>	<i>Code</i>	<i>Price</i>
<i>mm</i>	<i>DJxxx</i>	<i>Euro</i>
0,50	DJ050	4,40
0,60	DJ060	4,40
0,70	DJ070	4,40
0,80	DJ080	4,40
0,90	DJ090	4,40
1,00	DJ100	1,10
1,10	DJ110	1,10
1,20	DJ120	1,10
1,30	DJ130	1,10
1,40	DJ140	1,10
1,50	DJ150	1,10
1,60	DJ160	5,90
1,70	DJ170	5,90
1,80	DJ180	5,90
1,90	DJ190	5,90
2,00	DJ200	5,90
2,10	DJ210	5,90
2,20	DJ220	5,90
2,30	DJ230	5,90

Special diameters and tolerances available on request.

## Solid Carbide PCB Drills (Micro) Standard 65835/65836

Grain Size	< 0,4 $\mu\text{m}$
Helix Angle	30°
Point Angle	130°

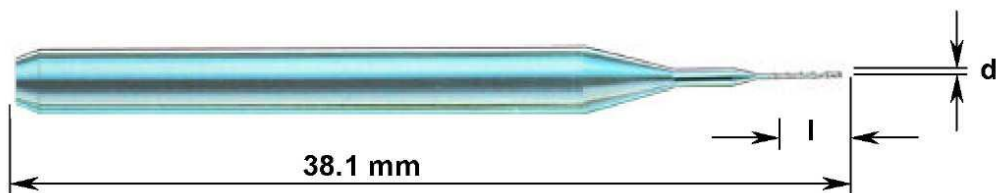

$d$ mm	$l$ mm	Code PMxxxxx	Price Euro	$d$ mm	$l$ mm	Code PMxxxxx	Price Euro
<b>0,100</b>	1,50	PM10015	2,90	<b>0,241</b>	2,50	PM24125	2,60
<b>0,110</b>	1,50	PM11015	2,90	<b>0,250</b>	2,50	PM25025	2,60
<b>0,120</b>	1,50	PM12015	2,90	<b>0,254</b>	2,50	PM25425	2,60
<b>0,130</b>	1,50	PM13015	2,90	<b>0,267</b>	2,50	PM26725	2,60
<b>0,140</b>	1,50	PM14015	2,90	<b>0,279</b>	2,50	PM27925	2,60
<b>0,150</b>	2,00	PM15020	2,90	<b>0,292</b>	3,50	PM29235	2,60
<b>0,160</b>	2,00	PM16020	2,90	<b>0,300</b>	3,50	PM30035	2,30
<b>0,170</b>	2,00	PM17020	2,90	<b>0,305</b>	3,50	PM30535	2,30
<b>0,180</b>	2,00	PM18020	2,90	<b>0,318</b>	3,50	PM31835	2,30
<b>0,191</b>	2,00	PM19120	2,90	<b>0,330</b>	3,50	PM33035	2,30
<b>0,200</b>	2,00	PM20020	2,90	<b>0,343</b>	3,50	PM34335	2,30
<b>0,211</b>	2,50	PM21125	2,60				
<b>0,221</b>	2,50	PM22125	2,60				
<b>0,231</b>	2,50	PM23125	2,60				

Special diameters and tolerances available on request.

## Solid Carbide PCB Drills (Normal) Standard 65835/65836

Grain Size	0,5..0,8 $\mu\text{m}$
Helix Angle	33°
Point Angle	130°

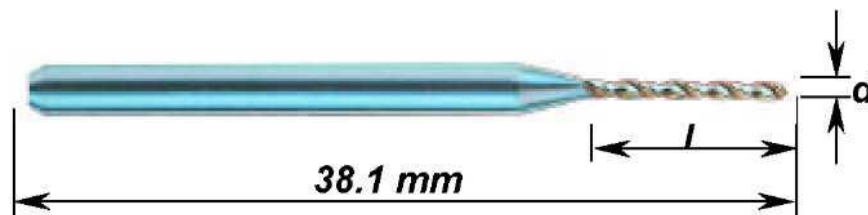

<i>d</i>	<i>l</i>	<i>Code</i>	<i>Price</i>
<i>mm</i>	<i>mm</i>	<i>PNxxxxxx</i>	<i>Euro</i>
<b>0,35</b>	4,0	PN035040	2,15
<b>0,40</b>	4,5	PN040045	2,15
<b>0,45</b>	4,5	PN045045	2,15
<b>0,50</b>	5,0	PN050050	2,15
<b>0,55</b>	5,0	PN055050	2,00
<b>0,60</b>	6,0	PN060060	2,00
<b>0,65</b>	6,0	PN065060	2,00
<b>0,70</b>	10,0	PN070100	2,00
<b>0,75</b>	10,0	PN075100	2,00
<b>0,80</b>	10,0	PN080100	2,00
<b>0,85</b>	10,0	PN085100	1,90
<b>0,90</b>	10,0	PN090100	1,90
<b>0,95</b>	10,0	PN095100	1,90
<b>1,00</b>	10,0	PN100100	1,90
<b>1,05</b>	10,0	PN105100	1,90
<b>1,10</b>	10,0	PN110100	1,90
<b>1,15</b>	10,0	PN115100	1,90
<b>1,20</b>	10,0	PN120100	1,90

See next page for end of the table.



## Solid Carbide PCB Drills (Normal) Standard 65835/65836

See previous page for begin of the table.

<i>d</i>	<i>l</i>	<i>Code</i>	<i>Price</i>
<i>mm</i>	<i>mm</i>	<i>PNxxxxxx</i>	<i>Euro</i>
1,25	10,0	PN125100	1,90
1,30	10,0	PN130100	1,90
1,35	10,0	PN135100	1,90
1,40	10,0	PN140100	1,90
1,45	10,0	PN145100	1,90
1,50	10,0	PN150100	1,90
1,55	10,0	PN155100	2,00
1,60	10,0	PN160100	2,00
1,65	10,0	PN165100	2,00
1,70	10,0	PN170100	2,00
1,75	10,0	PN175100	2,00
1,80	10,0	PN180100	2,00
1,85	10,0	PN185100	2,00
1,90	10,0	PN190100	2,00
1,95	10,0	PN195100	2,00
2,00	10,0	PN200100	2,00
2,05	10,0	PN205100	2,00
2,10	10,0	PN210100	2,00
2,15	10,0	PN215100	2,00
2,20	10,0	PN220100	2,00
2,25	10,0	PN225100	2,15
2,30	10,0	PN230100	2,15
2,35	10,0	PN235100	2,15
2,40	10,0	PN240100	2,15
2,45	10,0	PN245100	2,15
2,50	10,0	PN250100	2,15
2,55	10,0	PN255100	2,15
2,60	10,0	PN260100	2,15
2,65	10,0	PN265100	2,15
2,70	10,0	PN270100	2,15
2,75	10,0	PN275100	2,15
2,80	10,0	PN280100	2,15
2,85	10,0	PN285100	2,15
2,90	10,0	PN290100	2,15
2,95	10,0	PN295100	2,15
3,00	10,0	PN300100	2,15

Special diameters and tolerances available on request.

## Solid Carbide PCB Drills (Large) Standard 65835/65836

Grain Size	0,7..1,0 $\mu\text{m}$
Helix Angle	34°
Point Angle	160°

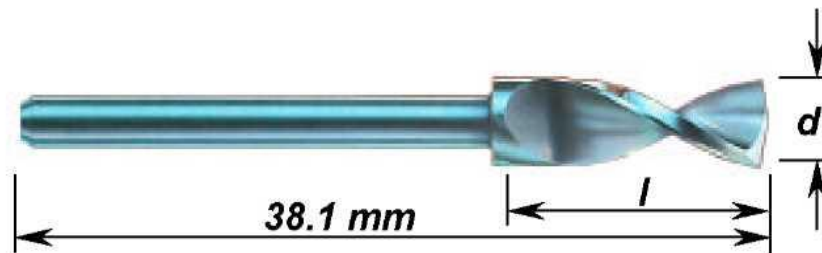

<i>d</i> mm	Code PLxxx	Price Euro	<i>d</i> mm	Code PLxxx	Price Euro	<i>d</i> mm	Code PLxxx	Price Euro
3,05	PL305	2,40	3,75	PL375	4,60	5,00	PL500	7,60
3,10	PL310	2,40	3,80	PL380	4,60	5,10	PL510	8,90
3,175	PL318	2,40	3,85	PL385	4,60	5,20	PL520	8,90
3,15	PL315	2,40	3,90	PL390	4,60	5,30	PL530	8,90
3,20	PL320	2,40	3,95	PL395	4,60	5,40	PL540	8,90
3,25	PL325	2,90	4,00	PL400	4,60	5,50	PL550	8,90
3,30	PL330	2,90	4,10	PL410	5,60	5,60	PL560	9,90
3,35	PL335	2,90	4,20	PL420	5,60	5,70	PL570	9,90
3,40	PL340	2,90	4,30	PL430	5,60	5,80	PL580	9,90
3,45	PL345	2,90	4,40	PL440	5,60	5,90	PL590	9,90
3,50	PL350	2,90	4,50	PL450	5,60	6,00	PL600	9,90
3,55	PL355	4,60	4,60	PL460	7,60	6,10	PL610	10,90
3,60	PL360	4,60	4,70	PL470	7,60	6,20	PL620	10,90
3,65	PL365	4,60	4,80	PL480	7,60	6,30	PL630	10,90
3,70	PL370	4,60	4,90	PL490	7,60	6,35	PL635	10,90

Special diameters and tolerances available on request.



## PCB Routers Diacut Standard 60812/60813

Grain Size	0,4..0,5 $\mu\text{m}$
Helix Angle	24°
Point Angle	120°

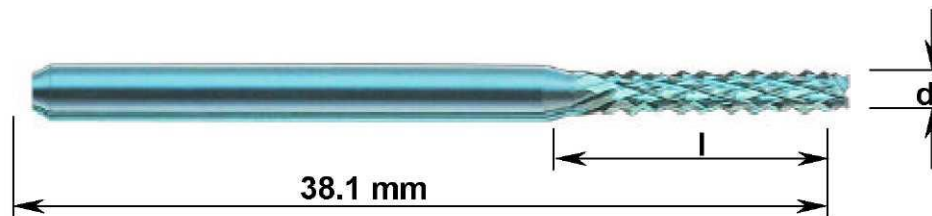

<i>d</i>	<i>l</i>	<i>Code</i>	<i>Price</i>	<i>d</i>	<i>l</i>	<i>Code</i>	<i>Price</i>
<i>mm</i>	<i>mm</i>	<i>PDxxxxx</i>	<i>Euro</i>	<i>mm</i>	<i>mm</i>	<i>PDxxxxx</i>	<i>Euro</i>
0,80	4,0	PD08040	2,40	2,00	8,5	PD20085	2,60
0,90	4,0	PD09040	2,40	2,10	8,5	PD21085	2,60
1,00	5,0	PD10050	2,40	2,20	8,5	PD22085	2,60
1,10	5,0	PD11050	2,40	2,30	8,5	PD23085	2,60
1,20	5,0	PD12050	2,40	2,40	8,5	PD24085	2,60
1,30	5,0	PD13050	2,40	2,50	8,5	PD25085	2,60
1,40	5,0	PD14050	2,40	2,60	8,5	PD26085	2,60
1,50	5,0	PD15050	2,40	2,70	8,5	PD27085	2,60
1,60	7,0	PD16070	2,60	2,80	8,5	PD28085	2,60
1,70	7,0	PD17070	2,60	2,90	8,5	PD29085	2,60
1,80	7,0	PD18070	2,60	3,00	10,5	PD30105	2,60
1,90	7,0	PD19070	2,60	3,10	10,5	PD31105	2,60
				3,175	10,5	PD31855	2,60

Special diameters and tolerances available on request.

## PCB Routers Chipbreaker Standard 60842/60843

Grain Size	0,4..0,5 $\mu\text{m}$
Helix Angle	18°
Point Angle	120°

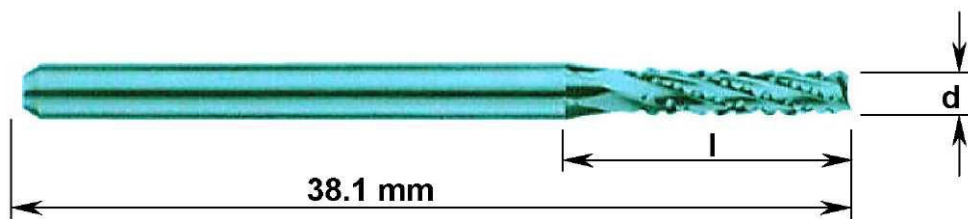

<i>d</i> mm	<i>l</i> mm	<i>Code</i> PCxxxxx	<i>Price</i> Euro	<i>d</i> mm	<i>l</i> mm	<i>Code</i> PCxxxxx	<i>Price</i> Euro
0,80	4,0	PC08040	2,20	2,00	8,5	PC20085	2,40
0,90	4,0	PC09040	2,20	2,10	8,5	PC21085	2,40
1,00	5,0	PC10050	2,20	2,20	8,5	PC22085	2,40
1,10	5,0	PC11050	2,20	2,30	8,5	PC23085	2,40
1,20	5,0	PC12050	2,20	2,40	8,5	PC24085	2,40
1,30	5,0	PC13050	2,20	2,50	8,5	PC25085	2,40
1,40	5,0	PC14050	2,20	2,60	8,5	PC26085	2,40
1,50	5,0	PC15050	2,20	2,70	8,5	PC27085	2,40
1,60	7,0	PC16070	2,40	2,80	8,5	PC28085	2,40
1,70	7,0	PC17070	2,40	2,9	8,5	PC29085	2,40
1,80	7,0	PC18070	2,40	3,00	12,0	PC30120	2,40
1,90	7,0	PC19070	2,40	3,10	12,0	PC31120	2,40
				3,175	12,0	PC31870	2,40

Special diameters and tolerances available on request.

## Solid Carbide Center Drills Types C90 and C120

<b>Grain Size</b>	0,5..0,8 $\mu\text{m}$
<b>Helix Angle</b>	18°
<b>Point Angle</b>	90° or 120°

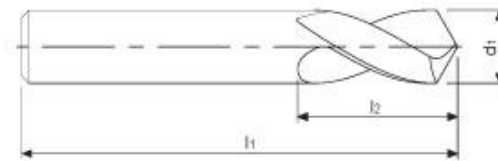

<b>d1 h6</b>	<b>L</b>	<b>L1</b>	<b>Code</b>	<b>Price</b>
<i>mm</i>	<i>mm</i>	<i>mm</i>	C90xxxx	<i>Euro</i>
<b>3,00</b>	45,0	12,0	C900300	9,70
<b>4,00</b>	50,0	15,0	C900400	14,20
<b>5,00</b>	50,0	18,0	C900500	18,10
<b>6,00</b>	50,0	21,0	C900600	22,30

<b>d1 h6</b>	<b>L</b>	<b>L1</b>	<b>Code</b>	<b>Price</b>
<i>mm</i>	<i>mm</i>	<i>mm</i>	C120xxxx	<i>Euro</i>
<b>3,00</b>	45,0	12,0	C1200300	9,70
<b>4,00</b>	50,0	15,0	C1200400	14,20
<b>5,00</b>	50,0	18,0	C1200500	18,10
<b>6,00</b>	50,0	21,0	C1200600	22,30

Special diameters and tolerances available on request.

## Solid Carbide Double Center Drills Type 2C (DIN 333-A)

<b>Grain Size</b>	0,5..0,8 $\mu\text{m}$
<b>Helix Angle</b>	30°
<b>Point Angle</b>	120°

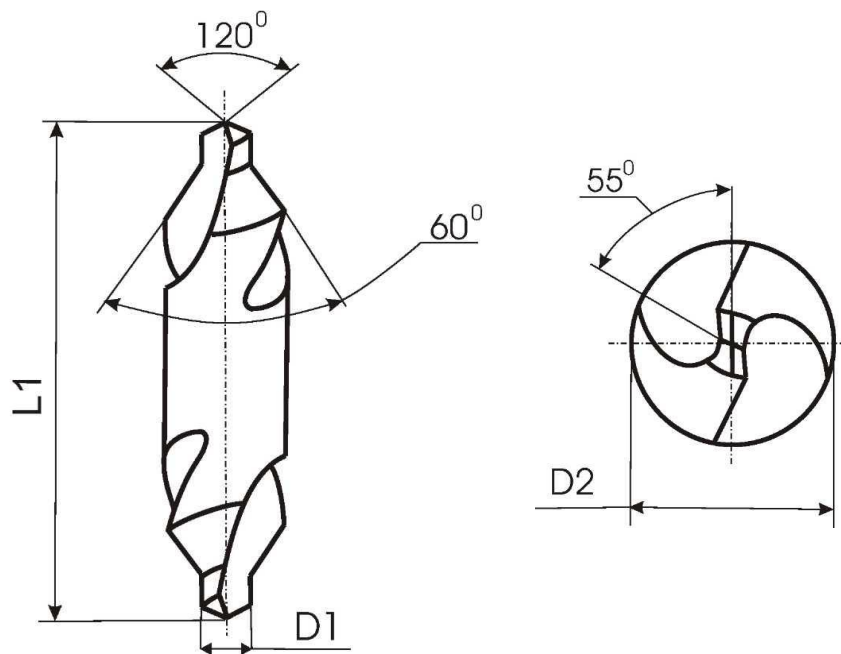

<b>D1 k13</b>	<b>D2 h8</b>	<b>L1</b>	<b>Code</b>	<b>Price</b>
<i>mm</i>	<i>mm</i>	<i>mm</i>	2Cxxx	<i>Euro</i>
0,50	3,15	25	2C050	15,90
0,80	3,15	25	2C080	16,90
1,00	3,15	31,5	2C100	17,90
1,25	3,15	31,5	2C125	18,90
1,60	4,00	35,5	2C160	20,90
2,00	5,00	40,0	2C200	22,90
2,50	6,30	45,0	2C250	26,90
3,15	8,00	50,0	2C315	30,90

Special diameters and tolerances available on request.

## Solid Carbide Micro End Mills

<b>Grain Size</b>	0,2..0,4 $\mu\text{m}$
<b>Helix Angle</b>	30°
<b>Point Angle</b>	0°

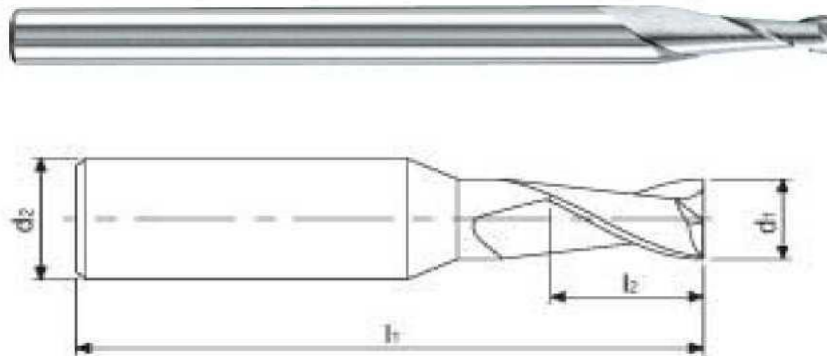

Shank diameter:  $d_2=3,00$  mm;

Overall length  $l_1=38,1$  mm;

Two cutting edges.

<b><i>d1 h10</i></b> <i>mm</i>	<b><i>l2</i></b> <i>mm</i>	<b><i>Code</i></b> <i>EMxxx</i>	<b><i>Price</i></b> <i>Euro</i>
0,30	1,00	EM030	17,50
0,40	1,00	EM040	16,50
0,50	1,50	EM050	15,50
0,60	1,50	EM060	15,00
0,70	2,00	EM070	15,00
0,80	2,00	EM080	14,50
0,90	2,50	EM090	14,50
1,00	3,00	EM100	14,00
1,10	3,00	EM110	13,50
1,20	4,0	EM120	13,50
1,30	4,0	EM130	13,00
1,40	4,0	EM140	13,00
1,50	4,0	EM150	13,00
1,60	4,0	EM160	13,00
1,70	5,0	EM170	13,00
1,80	5,0	EM180	13,00
1,90	5,0	EM190	13,00
2,00	5,0	EM200	12,50

Special diameters and tolerances available on request.



## SOLID CARBIDE TOOLS IN EXCELLENCE

### AS-EM121

DIN 6528

MICRO GRAIN SOLID CARBIDE END MILLS

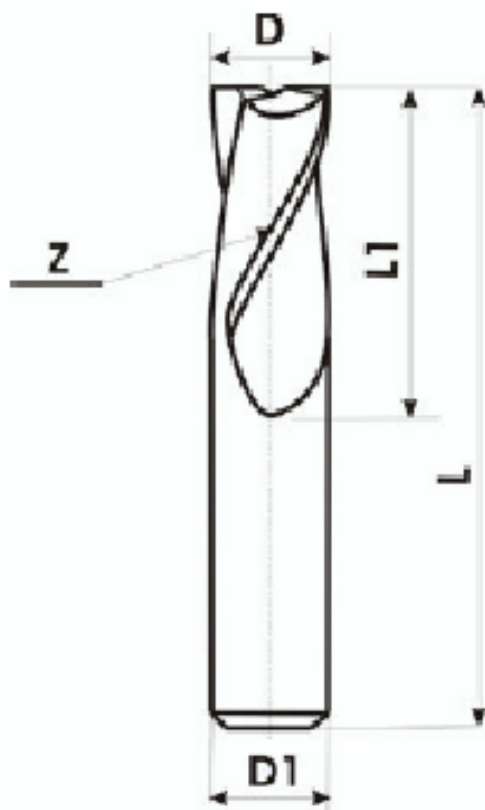















Twist end mill, Z=2 flute  
Over-centre cutting

D mm h11	D1 mm h6	L mm	L-1 mm	Price EURO
2,00	2,00	42	6	9,10
2,50	2,50	42	7	10,85
3,00	3,00	45	7	12,70
3,50	3,50	50	8	14,45
4,00	4,00	50	8	18,00
5,00	5,00	50	10	20,95
6,00	6,00	57	10	25,30

## Solid Carbide Mini Burs

<b>Grain Size</b>	0,5..0,8 $\mu\text{m}$
<b>Helix Angle</b>	14°..30°
<b>Point Angle</b>	0°











Shank diameter for all sizes: 2,35 mm.

<b>Code</b>	<b>Group</b>	<b>Shape</b>	<b>Head diameter</b>	<b>Flute Length</b>	<b>Overall Length</b>	<b>Price</b>
<i>ID</i>	-	-	<i>mm</i>	<i>mm</i>	<i>mm</i>	<i>Euro</i>
<b>B1</b>	A		2	0,6	44,5	4,50
<b>B2</b>	A		2	0,6	44,5	4,50
<b>B3</b>	A		1	1,8	44,5	4,50
<b>B4</b>	A		1,6	1,6	44,5	4,50
<b>B5</b>	A		2,3	2,5	44,5	4,50
<b>B6</b>	A		2,3	4,3	44,5	4,50
<b>B7</b>	A		2,3	5	44,5	4,50
<b>B8</b>	A		1,6	4,5	44,5	4,50
<b>B9</b>	A		2	6	44,5	4,50
<b>B10</b>	A		2	5	44,5	4,50
<b>B11</b>	A		1,8	5	44,5	4,50
<b>B12</b>	A		1,8	6	44,5	4,50
<b>B13</b>	A		1,7	5	44,5	4,50
<b>B14</b>	B		1,4	5	44,5	4,90

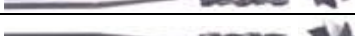
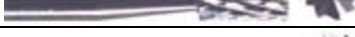
See next page for end of the table.

## Solid Carbide Mini Burs

See previous page for begin of the table.

<b>Code</b>	<b>Group</b>	<b>Shape</b>	<b>Head diameter</b>	<b>Flute Length</b>	<b>Overall Length</b>	<b>Price</b>
<i>ID</i>	-	-	<i>mm</i>	<i>mm</i>	<i>mm</i>	<i>Euro</i>
<b>B15</b>	A		1,2	5,7	44,5	4,50
<b>B16</b>	B		1,2	4,6	44,5	5,40
<b>B17</b>	C		1,4	5	44,5	5,90
<b>B18</b>	B		2,2	5	44,5	5,40
<b>B19</b>	B		2,2	5	44,5	5,40
<b>B20</b>	C		2,2	5,5	44,5	5,90
<b>B21</b>	C		2,2	8	44,5	5,90
<b>B22</b>	D		2,2	15	50	7,40
<b>B23</b>	D		2,2	15	50	7,40
<b>B24</b>	D		2,2	15	50	7,40
<b>B25</b>	D		2,2	16	50	7,40

Special diameters and tolerances available on request.

## Solid Carbide Punch Pins

<b>Material</b>	Tungsten Carbide
<b>Grain Size</b>	0,4 $\mu\text{m}$

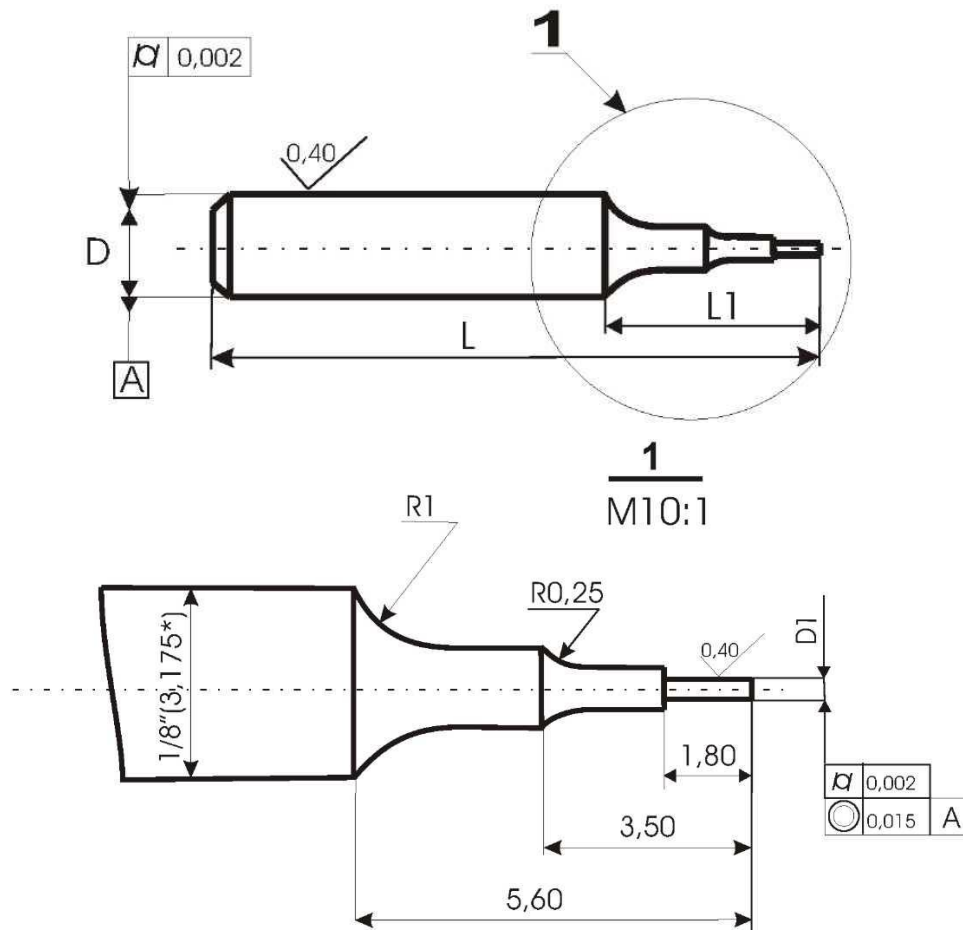

<b>D1</b> inch	<b>D1</b> mm	<b>Tolerance</b> mm	<b>Code</b> PPxxx	<b>Price</b> Euro
0,004	0,102	-0.002	PP004	6,90
0,005	0,127	-0.003	PP005	6,60
0,006	0,152	-0.004	PP006	6,20
0,008	0,203	-0.004	PP008	5,70
0,010	0,254	-0.004	PP010	5,40

Special diameters and tolerances available on request.

## Solid Carbide V-Groove Routers



<b>Material</b>	Tungsten Carbide
<b>Grain Size</b>	0,2..0,5 µm

<b>D</b> <i>mm</i>	<b>Tolerance</b> -	<b>L</b> <i>mm</i>	<b>Angle</b> <i>Grad</i>	<b>Code</b> <i>VRxxx</i>	<b>Price</b> <i>Euro</i>
<b>2,000</b>	<b>h6</b>	32,1-38,1	10°-90°	VR200	8,50
<b>3,000</b>	<b>h6</b>	32,1-38,1	30°-90°	VR300	9,00
<b>3,175</b>	<b>h6</b>	32,1-38,1	30°-90°	VR318	9,50
<b>4,000</b>	<b>h6</b>	38,1-50,1	40°-90°	VR400	11,50
<b>5,000</b>	<b>h6</b>	38,1-50,1	40°-90°	VR500	16,50
<b>6,000</b>	<b>h7</b>	38,1-50,1	40°-90°	VR600	20,50

Special diameters and tolerances available on request.